

043-C: Shake Smart

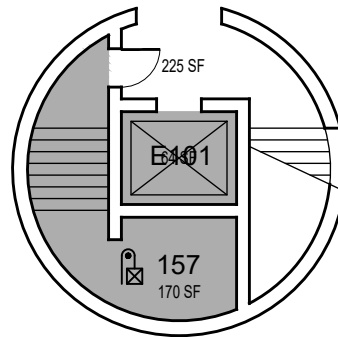

043-A: KINESIOLOGY

October 2020

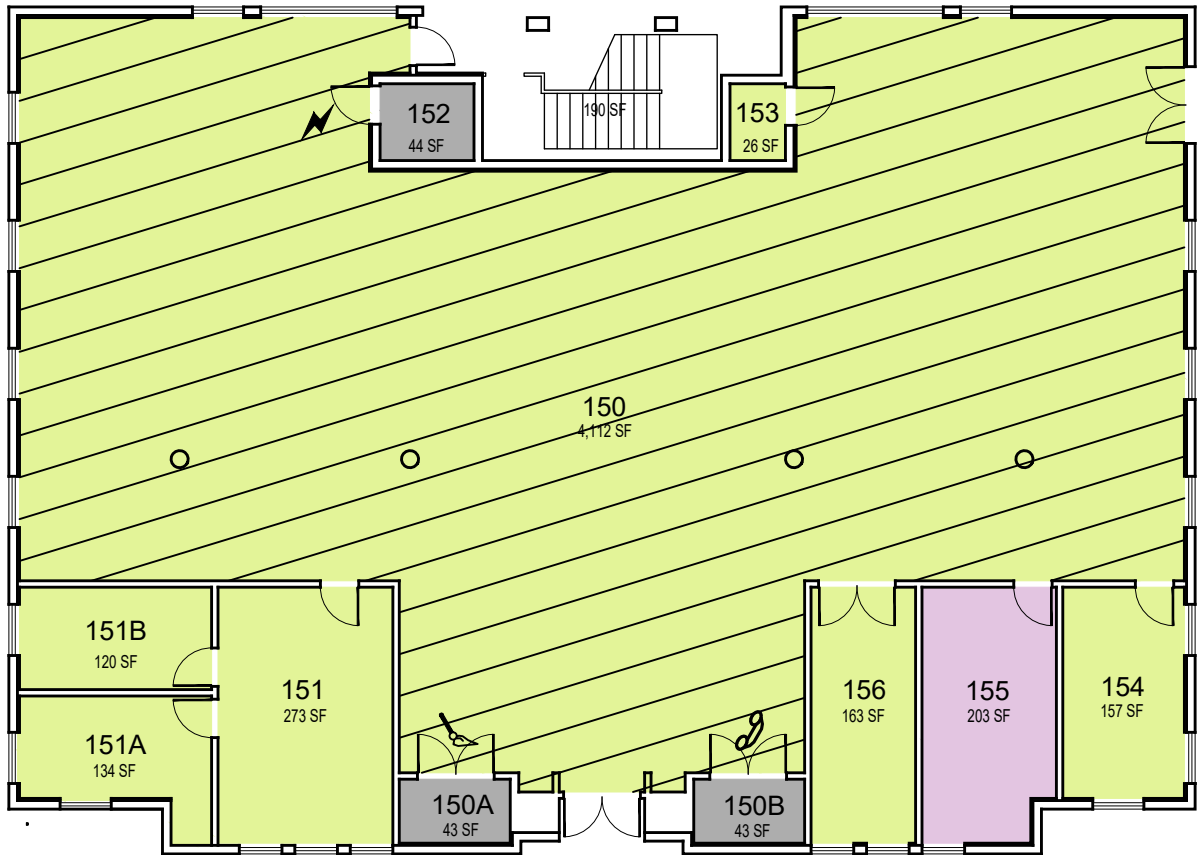

**CAL POLY**

Kinesiology

Floor 1  
Space Data [http://afd.calpoly.edu/facilities/spacefacility/space\\_data.asp](http://afd.calpoly.edu/facilities/spacefacility/space_data.asp)

FACILITIES MANAGEMENT AND DEVELOPMENT

000 UNASSIGN	400 STUDY	800 HEALTH
100 CLASS	500 SPECIAL	900 RESIDENTIAL
200 LAB	600 GENERAL	
300 OFFICE	700 SUPPORT	



1"=15'

Room Use

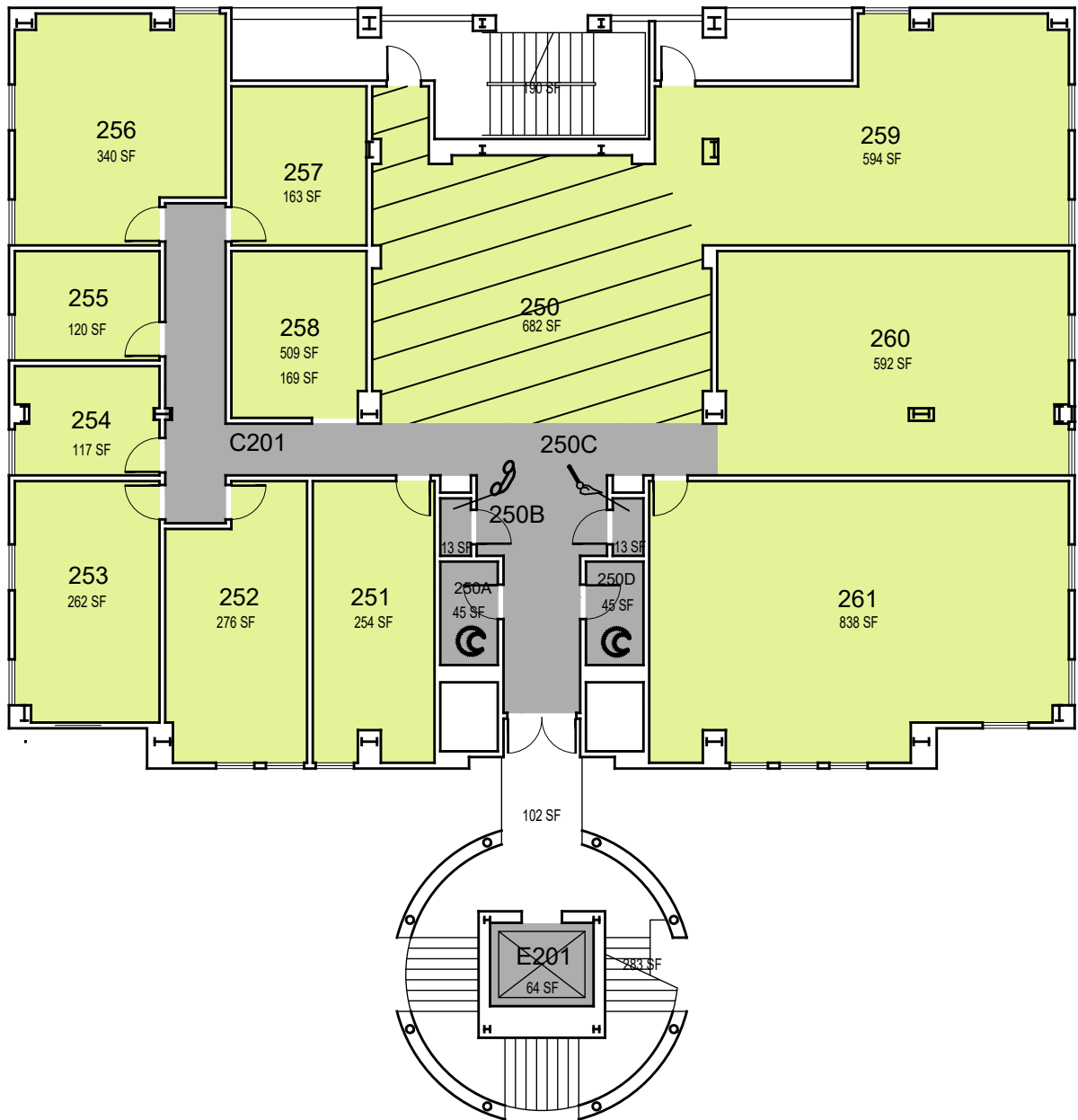

**CAL POLY**

Kinesiology

Floor 2  
Space Data [http://afd.calpoly.edu/facilities/spacefacility/space\\_data.asp](http://afd.calpoly.edu/facilities/spacefacility/space_data.asp)

FACILITIES MANAGEMENT AND DEVELOPMENT

000 UNASSIGN	400 STUDY	800 HEALTH
100 CLASS	500 SPECIAL	900 RESIDENTIAL
200 LAB	600 GENERAL	
300 OFFICE	700 SUPPORT	

Room Use

October 2020



1"=15'

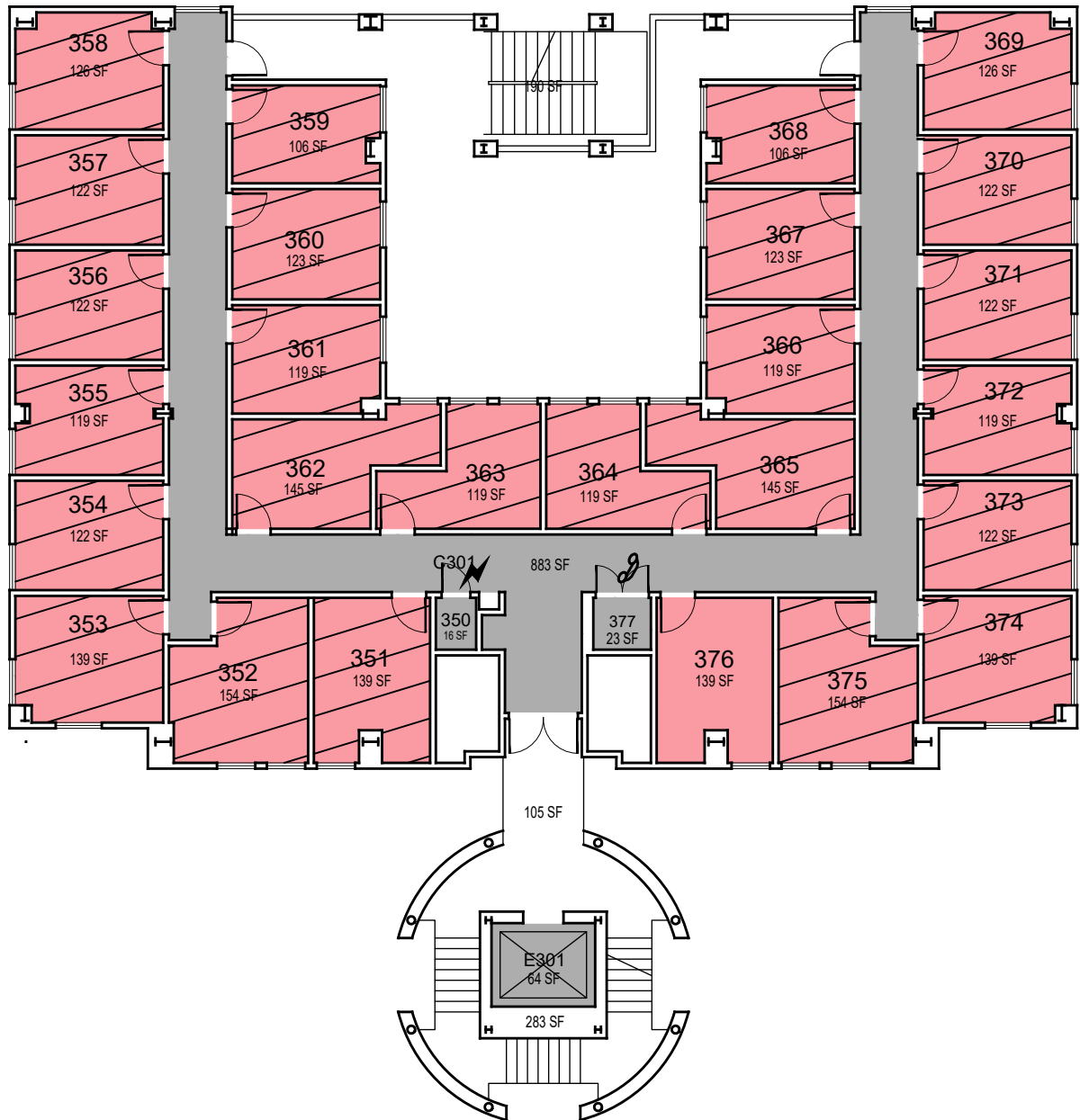

**CAL POLY**

Kinesiology

Floor 3  
Space Data [http://afd.calpoly.edu/facilities/spacefacility/space\\_data.asp](http://afd.calpoly.edu/facilities/spacefacility/space_data.asp)

FACILITIES MANAGEMENT AND DEVELOPMENT

000 UNASSIGN	400 STUDY	800 HEALTH
100 CLASS	500 SPECIAL	900 RESIDENTIAL
200 LAB	600 GENERAL	
300 OFFICE	700 SUPPORT	

October 2020

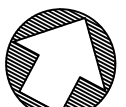

1"=15'

Room Use

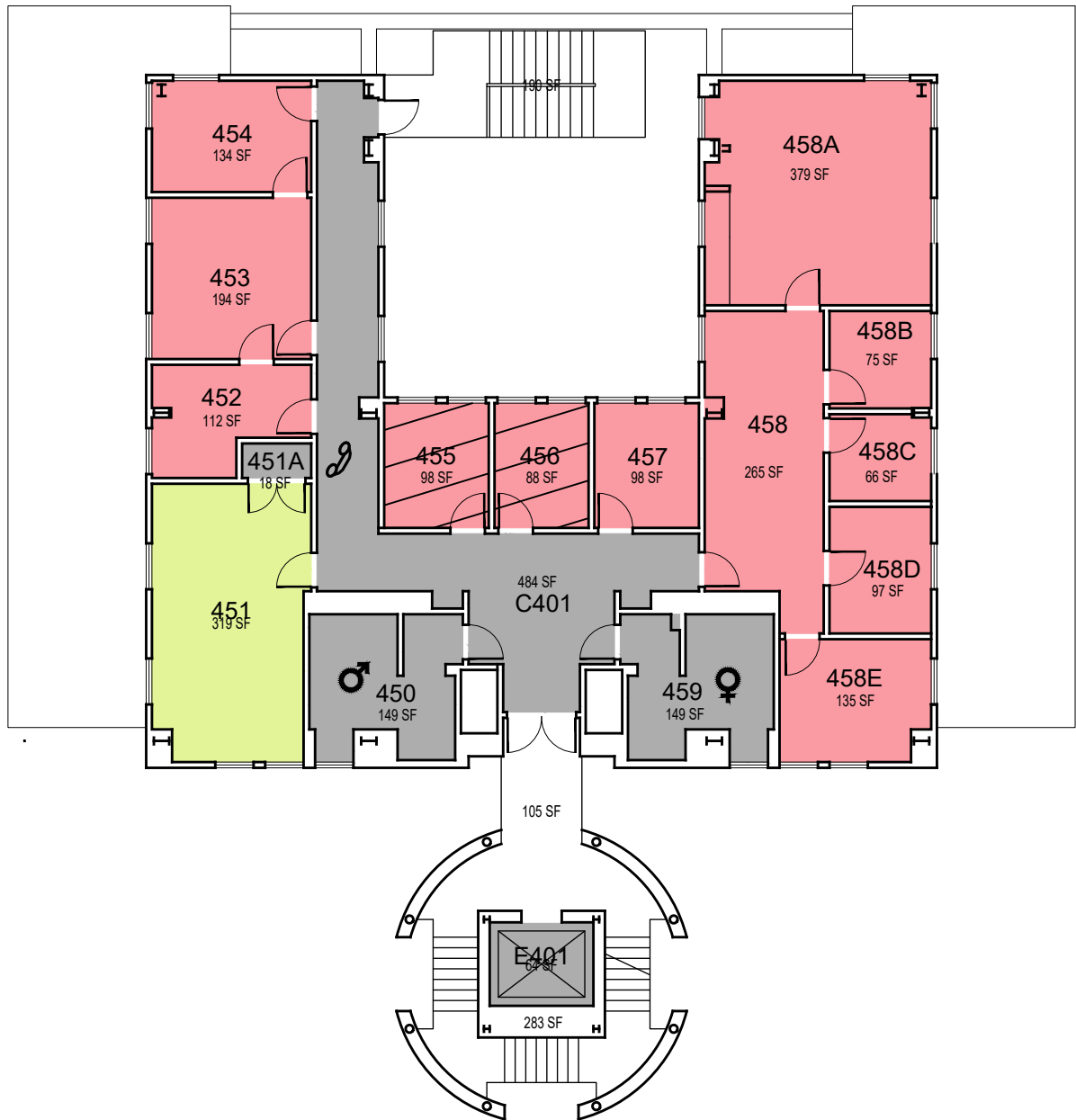

**CAL POLY**

Kinesiology

Floor 4  
Space Data [http://afd.calpoly.edu/facilities/spacefacility/space\\_data.asp](http://afd.calpoly.edu/facilities/spacefacility/space_data.asp)

FACILITIES MANAGEMENT AND DEVELOPMENT

000 UNASSIGN	400 STUDY	800 HEALTH
100 CLASS	500 SPECIAL	900 RESIDENTIAL
200 LAB	600 GENERAL	
300 OFFICE	700 SUPPORT	

Room Use

October 2020



1"=15'

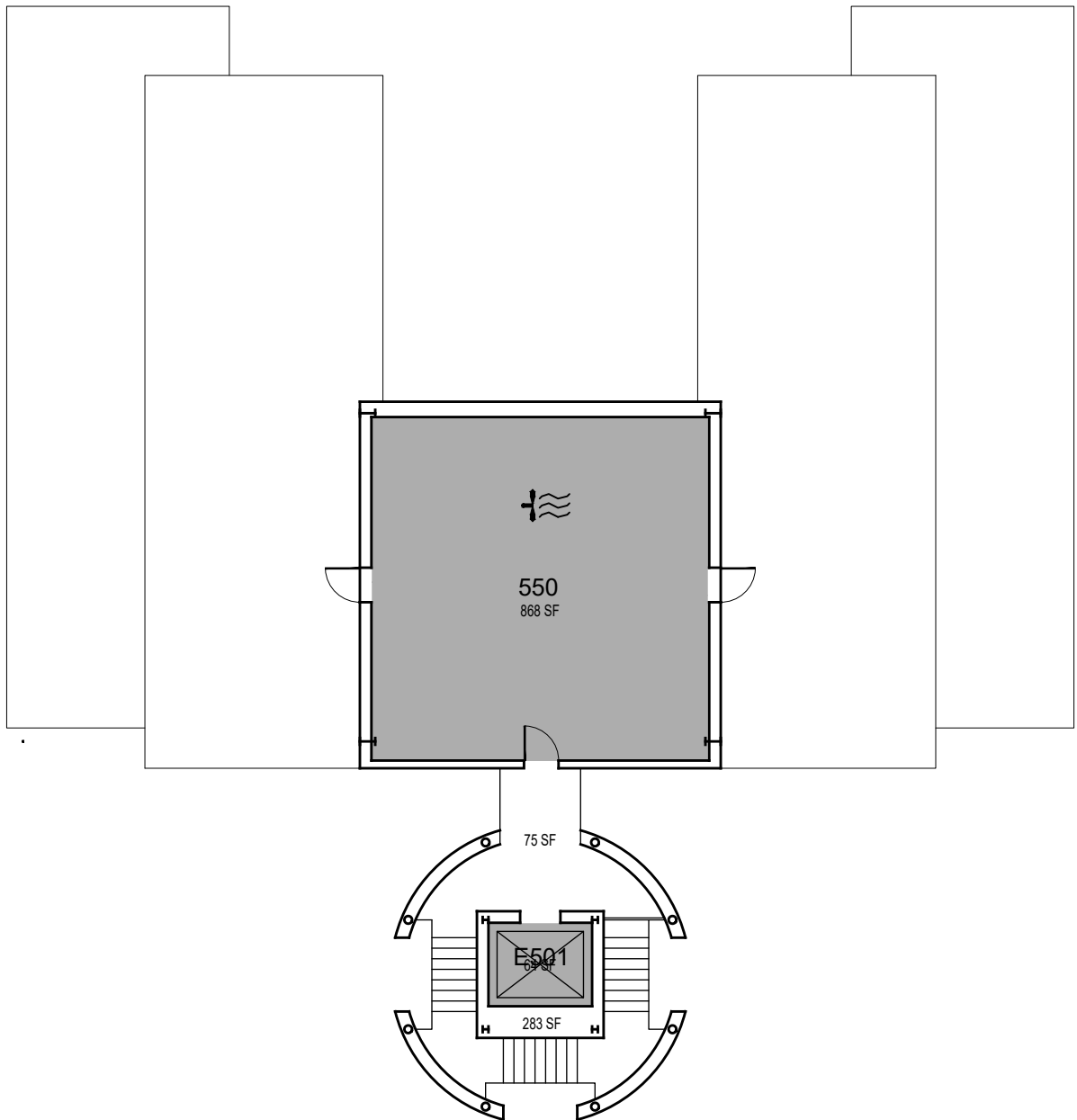

# Kinesiology

Mechanical Penthouse

Space Data [http://afd.calpoly.edu/facilities/spacefacility/space\\_data.asp](http://afd.calpoly.edu/facilities/spacefacility/space_data.asp)

FACILITIES MANAGEMENT AND DEVELOPMENT

000 UNASSIGN	400 STUDY	800 HEALTH
100 CLASS	500 SPECIAL	900 RESIDENTIAL
200 LAB	600 GENERAL	
300 OFFICE	700 SUPPORT	

Room Use

October 2020

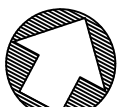

1"=15'