

043-C: Shake Smart

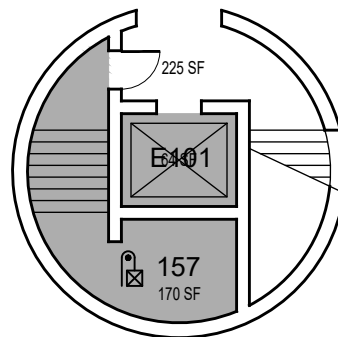

043-A: KINESIOLOGY

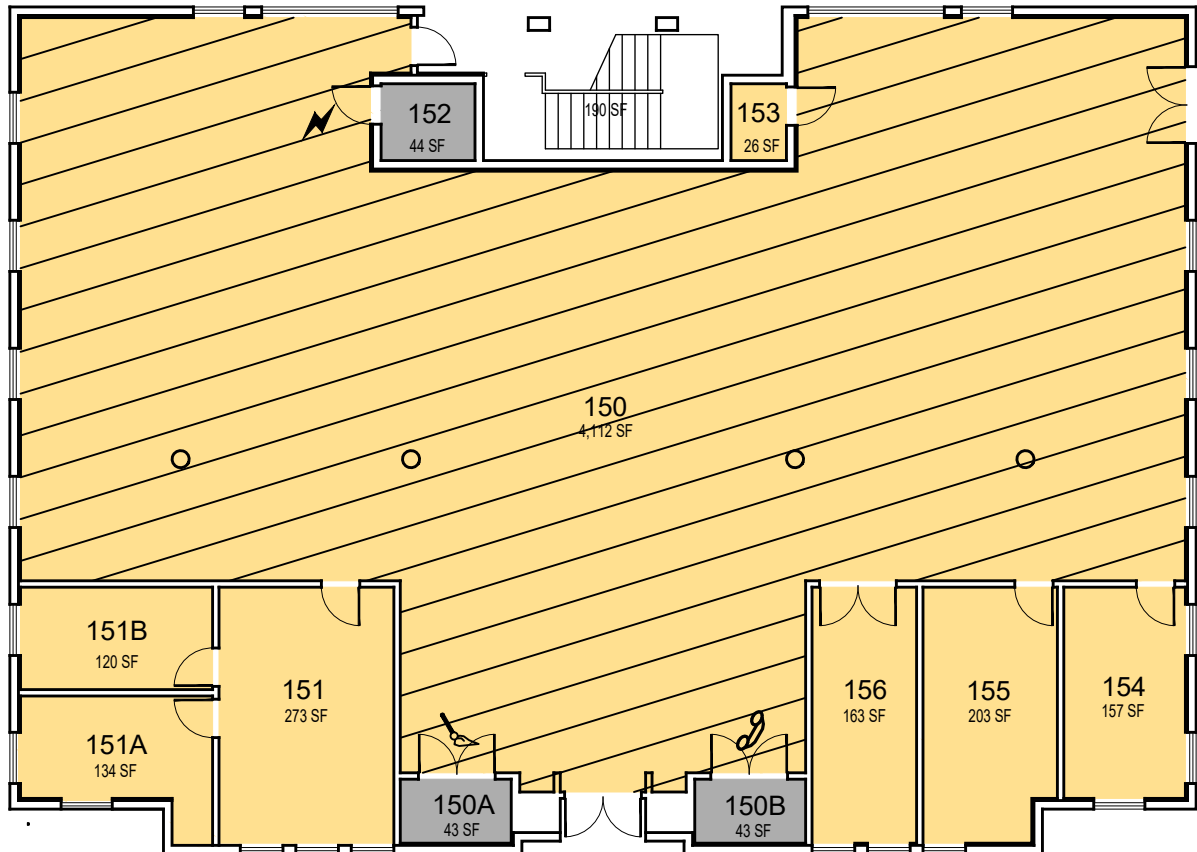

CAL POLY

Kinesiology

Floor 1
Space Data http://afd.calpoly.edu/facilities/spacefacility/space_data.asp

FACILITIES MANAGEMENT AND DEVELOPMENT

00000 UNASSIGN	107500 OCOB	120000 ACAD AFRS	137500 UNIV DEV
102500 CAFES	110000 CLA	120400 ITS	140000 STUD AFRS
105000 CAED	112500 CENG	121300 DIV/INCL	145000 PRESIDENT
117500 CSM	125000 AFD	150000 UNIV SUP	

College/Division

October 2020



1"=15'

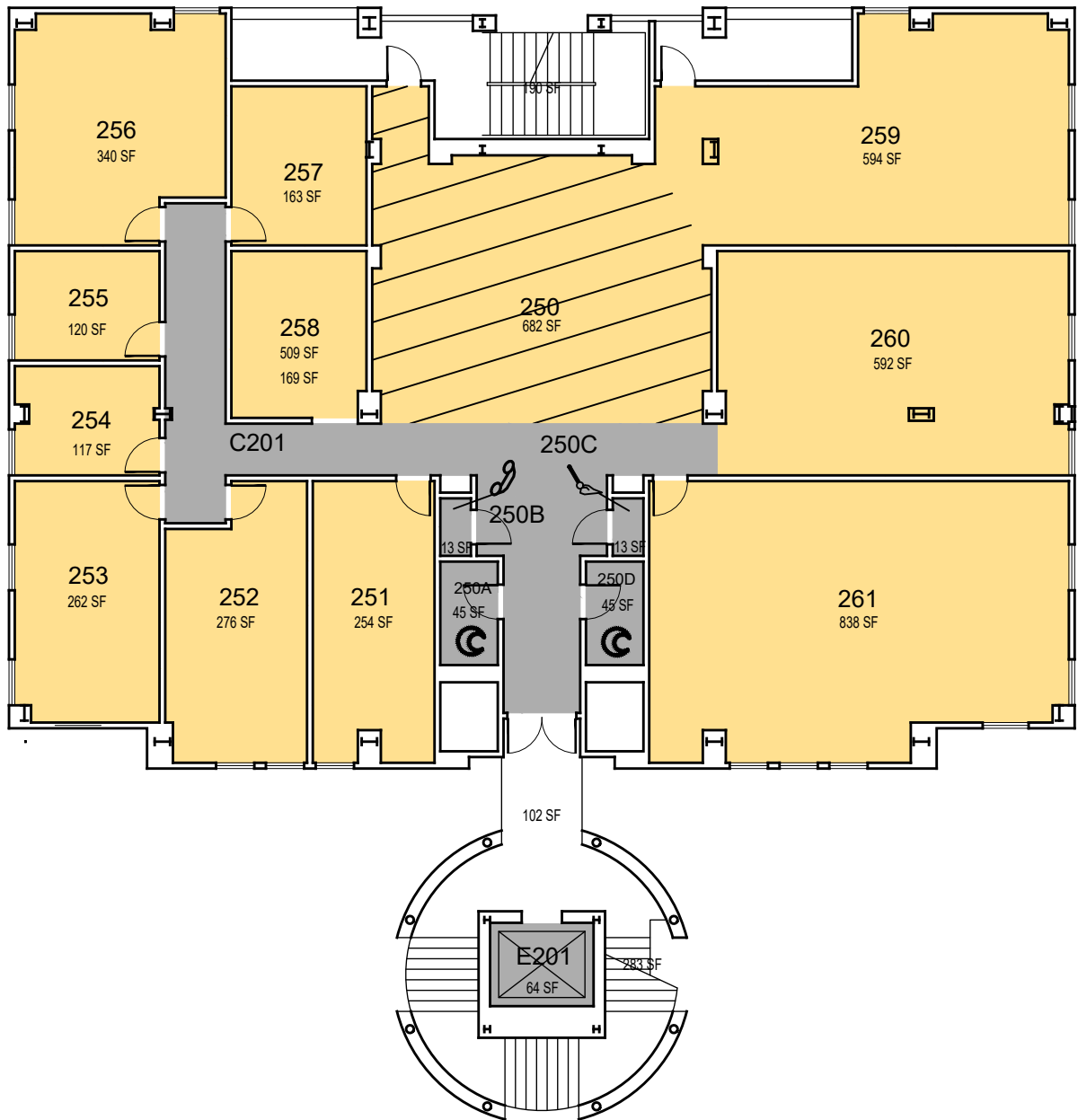

CAL POLY

Kinesiology

Floor 2
Space Data http://afd.calpoly.edu/facilities/spacefacility/space_data.asp

FACILITIES MANAGEMENT AND DEVELOPMENT

00000 UNASSIGN	107500 OCOB	120000 ACAD AFRS	137500 UNIV DEV
102500 CAFES	110000 CLA	120400 ITS	140000 STUD AFRS
105000 CAED	112500 CENG	121300 DIV/INCL	145000 PRESIDENT
117500 CSM	125000 AFD	150000 UNIV SUP	

College/Division

October 2020



1"=15'

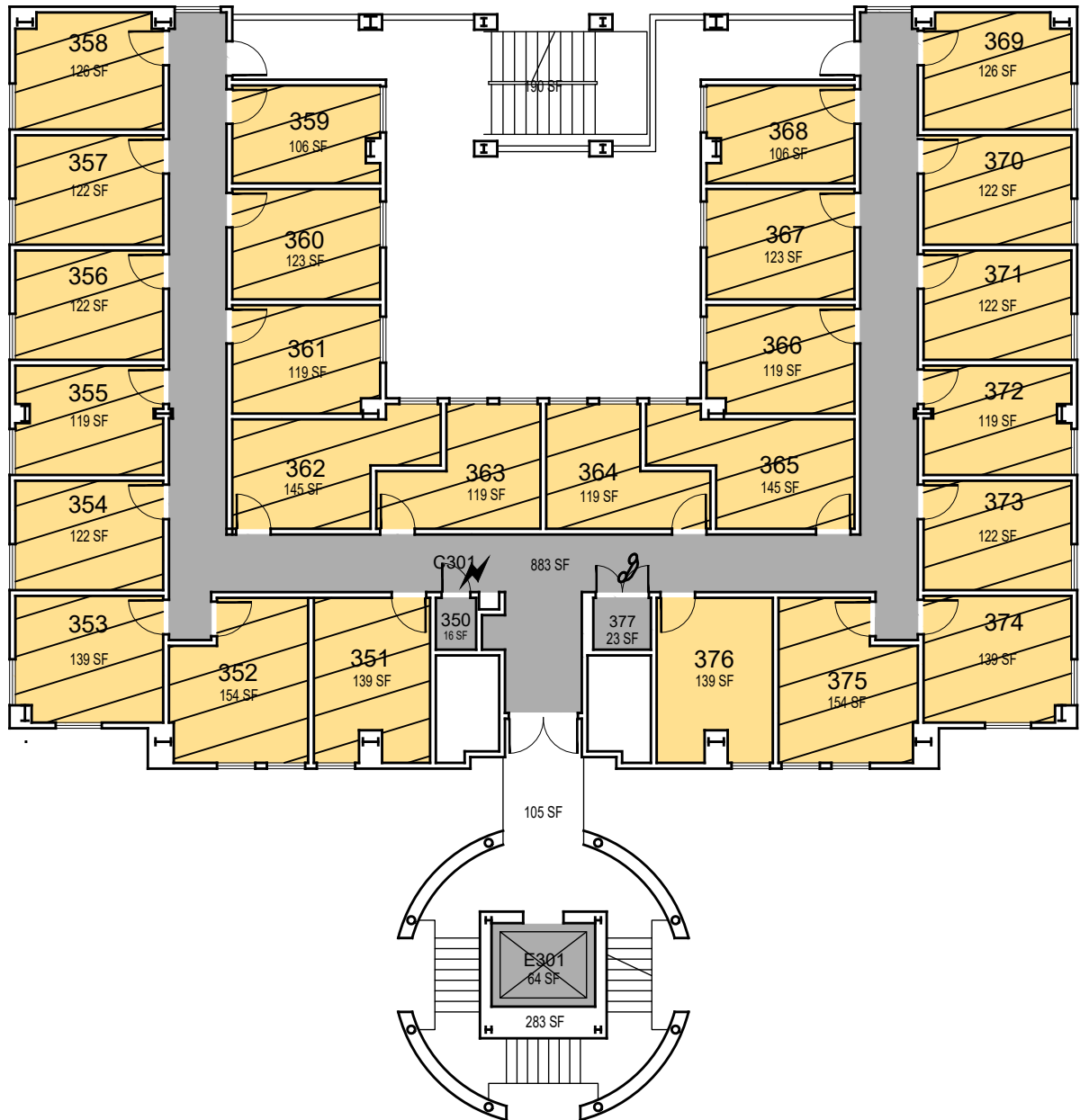

CAL POLY

Kinesiology

Floor 3

Space Data http://afd.calpoly.edu/facilities/spacefacility/space_data.asp

FACILITIES MANAGEMENT AND DEVELOPMENT

00000 UNASSIGN	107500 OCOB	120000 ACAD AFRS	137500 UNIV DEV
102500 CAFES	110000 CLA	120400 ITS	140000 STUD AFRS
105000 CAED	112500 CENG	121300 DIV/INCL	145000 PRESIDENT
117500 CSM	125000 AFD	150000 UNIV SUP	

College/Division

October 2020



1"=15'

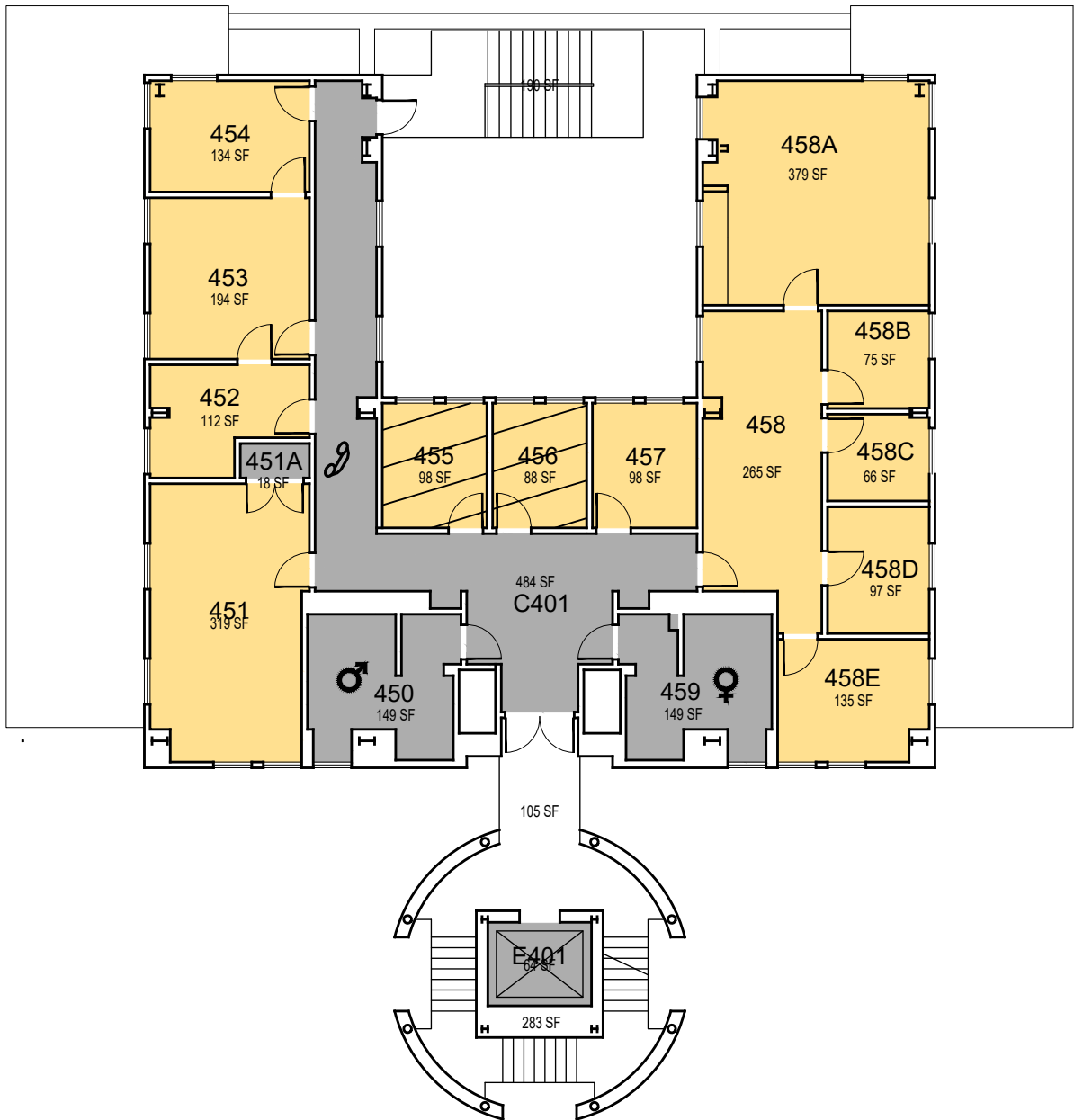

CAL POLY

Kinesiology

Floor 4

Space Data http://afd.calpoly.edu/facilities/spacefacility/space_data.asp

FACILITIES MANAGEMENT AND DEVELOPMENT

00000 UNASSIGN	107500 OCOB	120000 ACAD AFRS	137500 UNIV DEV
102500 CAFES	110000 CLA	120400 ITS	140000 STUD AFRS
105000 CAED	112500 CENG	121300 DIV/INCL	145000 PRESIDENT
117500 CSM	125000 AFD	150000 UNIV SUP	

College/Division

October 2020

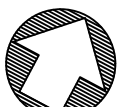

1"=15'

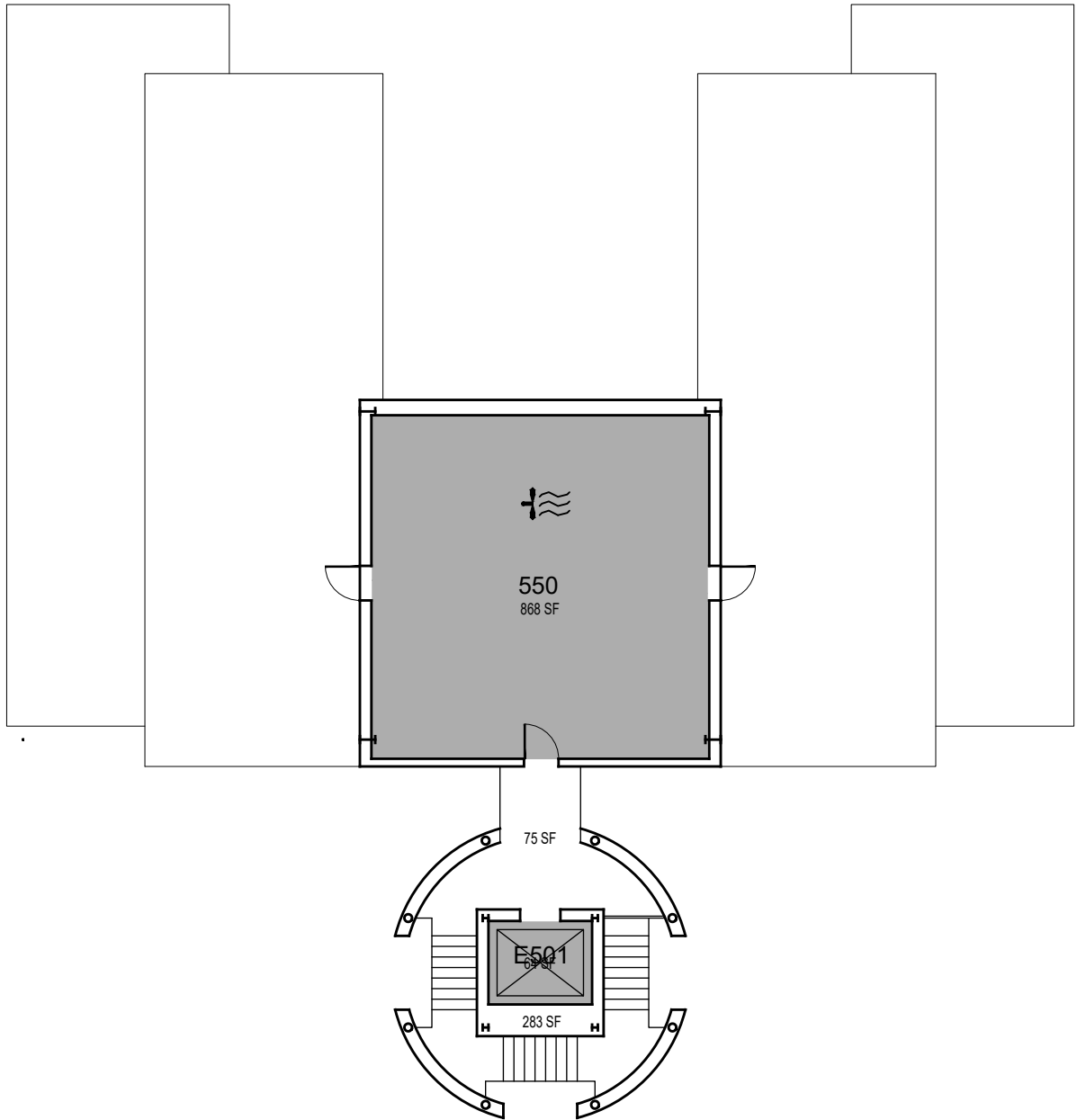

CAL POLY

Kinesiology

Mechanical Penthouse

Space Data http://afd.calpoly.edu/facilities/spacefacility/space_data.asp

FACILITIES MANAGEMENT AND DEVELOPMENT

00000 UNASSIGN	107500 OCOB	120000 ACAD AFRS	137500 UNIV DEV
102500 CAFES	110000 CLA	120400 ITS	140000 STUD AFRS
105000 CAED	112500 CENG	121300 DIV/INCL	145000 PRESIDENT
117500 CSM	125000 AFD	150000 UNIV SUP	

College/Division

October 2020

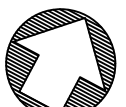

1"=15'