

Team Room

March 2022



Sports Complex

160-B

FACILITIES MANAGEMENT AND DEVELOPMENT

Space Data http://afd.calpoly.edu/facilities/spacefacility/space_data.asp



1:10

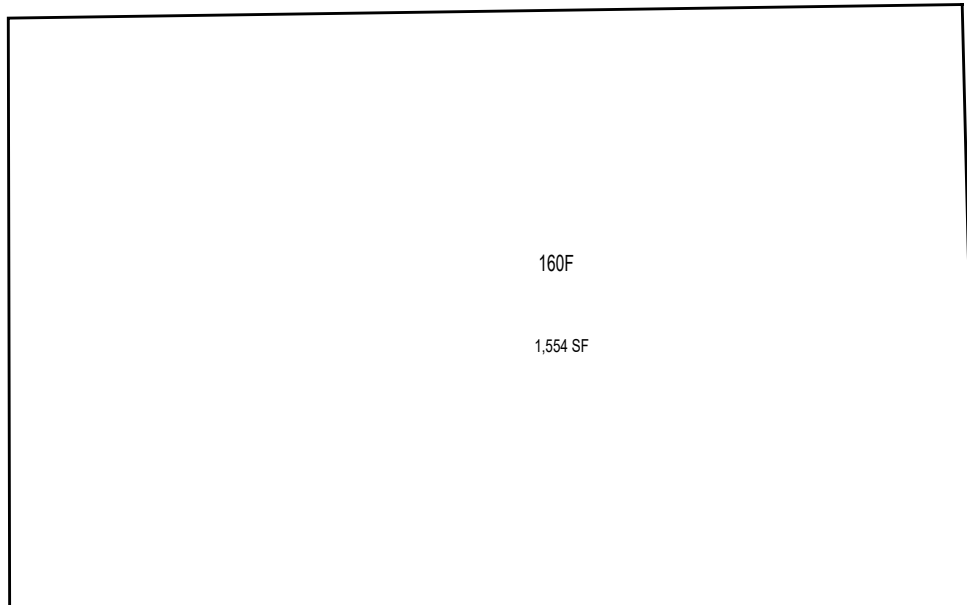

Maintenance Building (160-F)

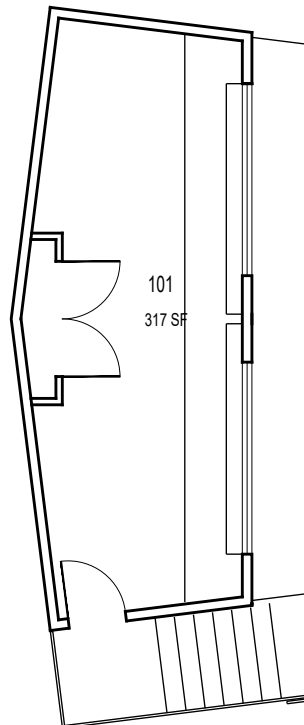

Press Box (160-C)

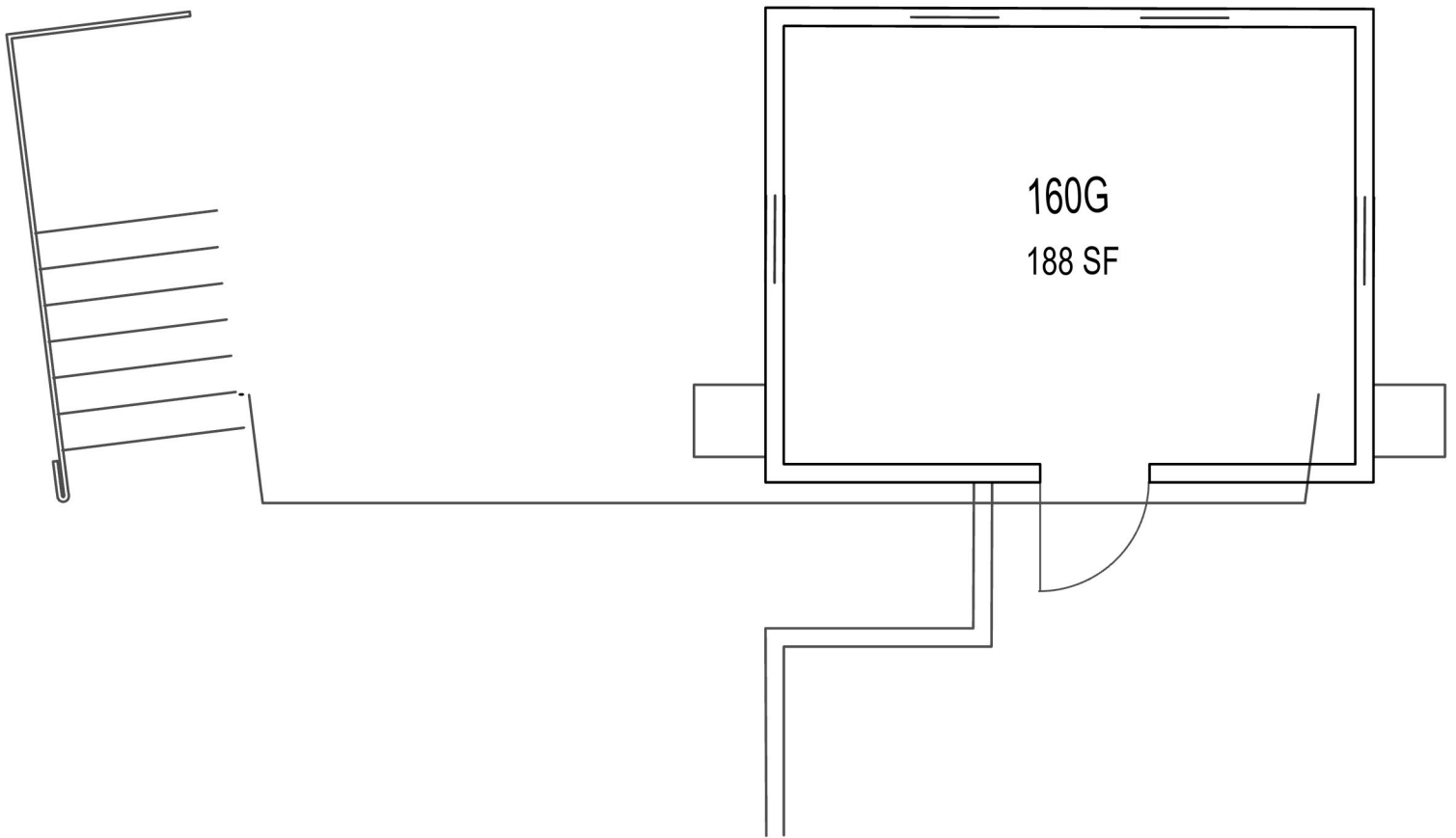

CAL POLY

FACILITIES MANAGEMENT AND DEVELOPMENT

Ticket Booth

Floor 1

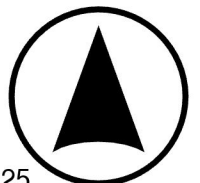

MAY 2025

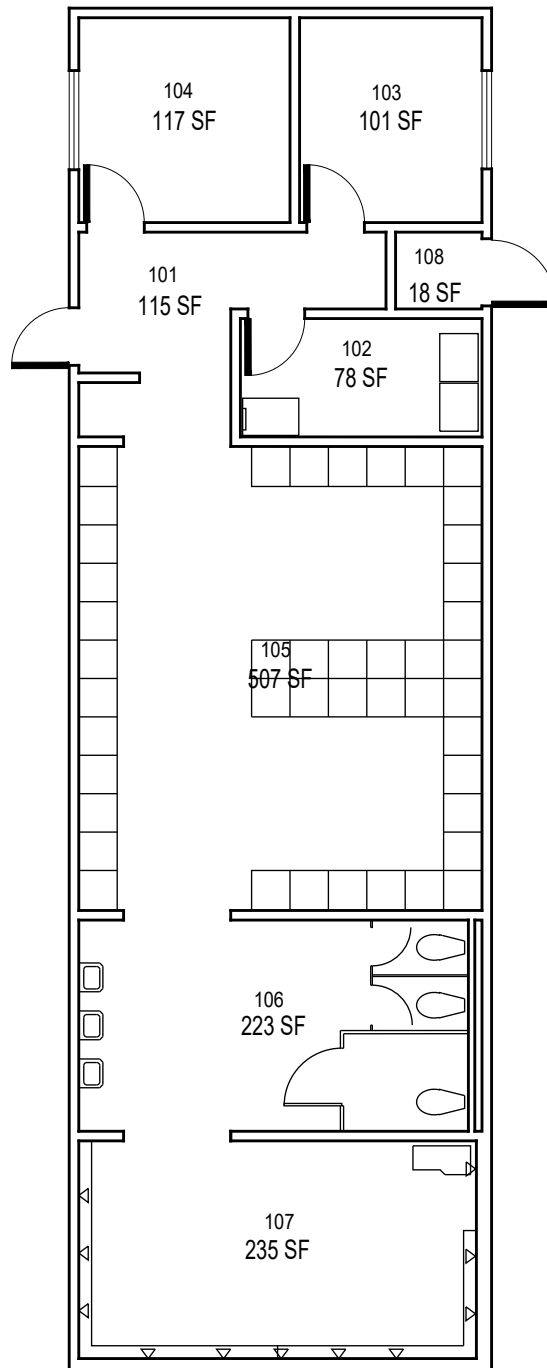

Softball Lockers

March 2022



Sports Complex

161-A

FACILITIES MANAGEMENT AND DEVELOPMENT

Space Data http://afd.calpoly.edu/facilities/spacefacility/space_data.asp



1:10

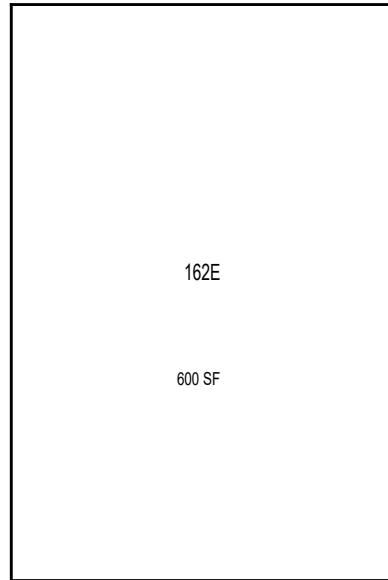

162-E Upper Fields Maintenance Shed

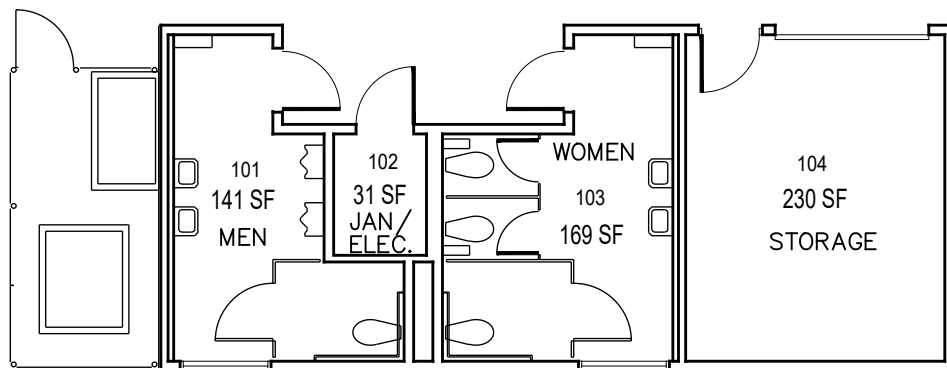

162-D Restroom 1

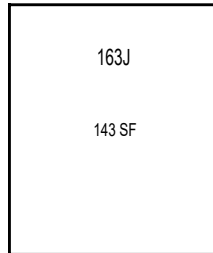

163-J South Scorekeepers Station

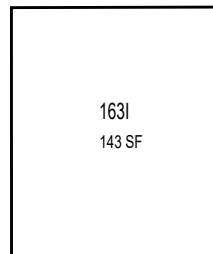

163-I Mid Scorekeepers Station

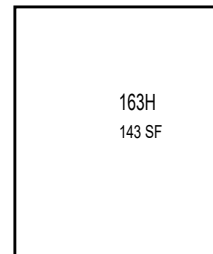

163-H North Scorekeepers Station