

O:\Planroom\Database\building_Floor_Plans\Plan_Book\Building 228-0_Center for Coastal Marine Sciences.dwg AutoCAD PDF (High Quality Print).pc3 ANSI full bleed A (8.50 x 11.00 Inches) cpdf.ctb

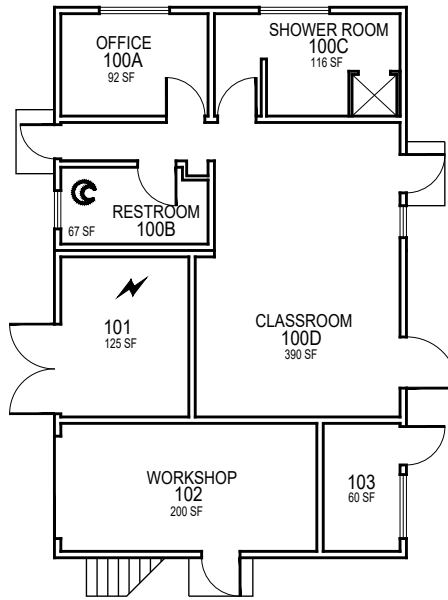

1st Floor
228-A
Pier Main Building



Center for Coastal Marine
Sciences
Bldg 228-A Floor 1

FACILITIES MANAGEMENT AND DEVELOPMENT

Space Data http://afd.calpoly.edu/facilities/spacefacility/space_data.asp

August 2022

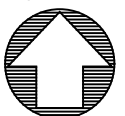

1" = 15'-0"

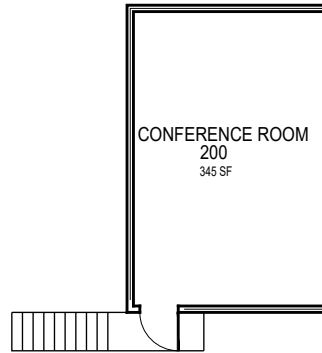

2nd Floor
228-A
Pier Main Building

O:\Planroom\Database\building_Floor_Plans\Plan_Book\Building 228-0_Center for Coastal Marine Sciences.dwg AutoCAD PDF (High Quality Print).pc3 ANSI full bleed A (8.50 x 11.00 Inches) cpdf.ctb



Center for Coastal Marine
Sciences
Bldg 228-A Floor 2

FACILITIES MANAGEMENT AND DEVELOPMENT

Space Data http://afd.calpoly.edu/facilities/spacefacility/space_data.asp

August 2022

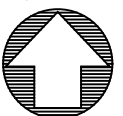

1" = 15'-0"

O:\Planroom\Database\building_Floor_Plans\Plan_Book\Building 228-0_Center for Coastal Marine Sciences.dwg AutoCAD PDF (High Quality Print).pc3 ANSI full bleed A (8.50 x 11.00 Inches) cpdf.ctb

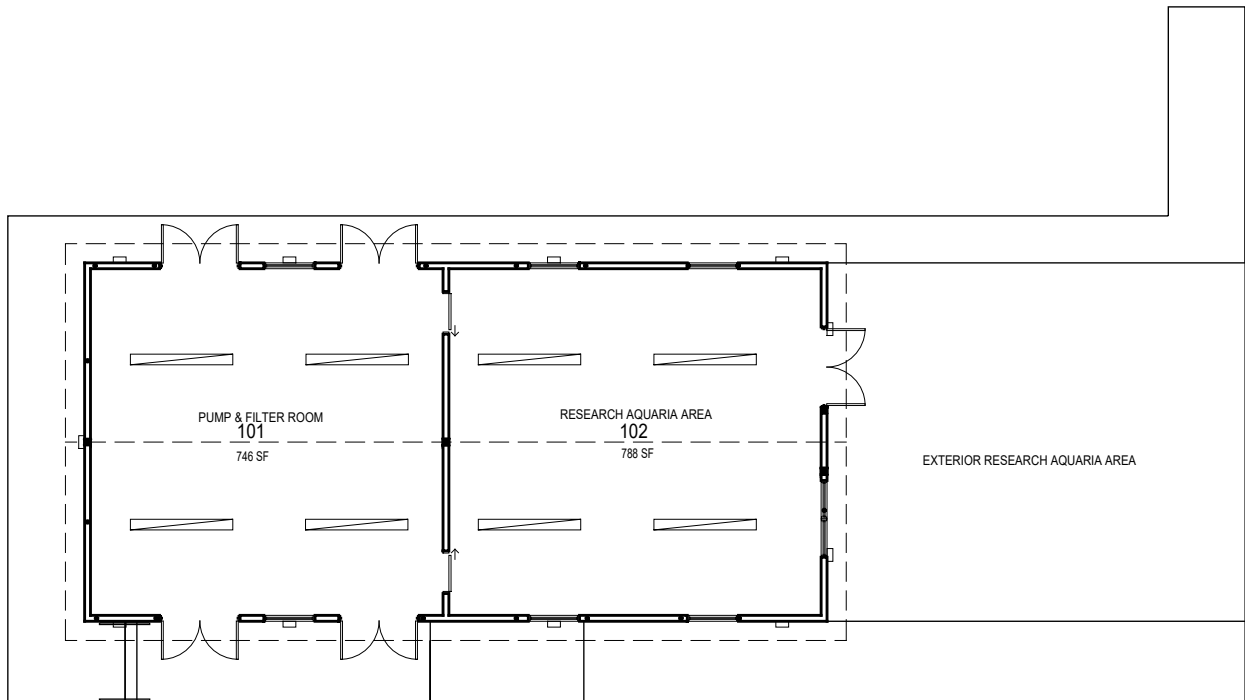

228-B Flowing Seawater Facility



Center for Coastal Marine
Sciences
Bldg 228-B Floor 1

FACILITIES MANAGEMENT AND DEVELOPMENT

Space Data http://afd.calpoly.edu/facilities/spacefacility/space_data.asp

August 2022

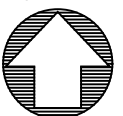

1" = 15'-0"

O:\Planroom\Database\building_Floor_Plans\Plan_Book\Building 228-0_Center for Coastal Marine Sciences.dwg AutoCAD PDF (High Quality Print).pc3 ANSI full bleed A (8.50 x 11.00 Inches) cpdf.ctb



228-G Pier Facility Storage Container

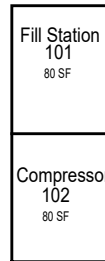

**228-D
Diving Support Locker**

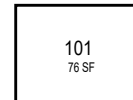

**228-E
Pier Paint Locker**

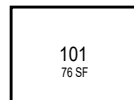

**228-F
Pier Boat Locker**



Center for Coastal Marine
Sciences
Multiple Bldgs Floor 1

FACILITIES MANAGEMENT AND DEVELOPMENT

Space Data http://afd.calpoly.edu/facilities/spacefacility/space_data.asp

August 2022

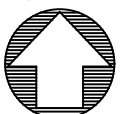

1" = 15'-0"

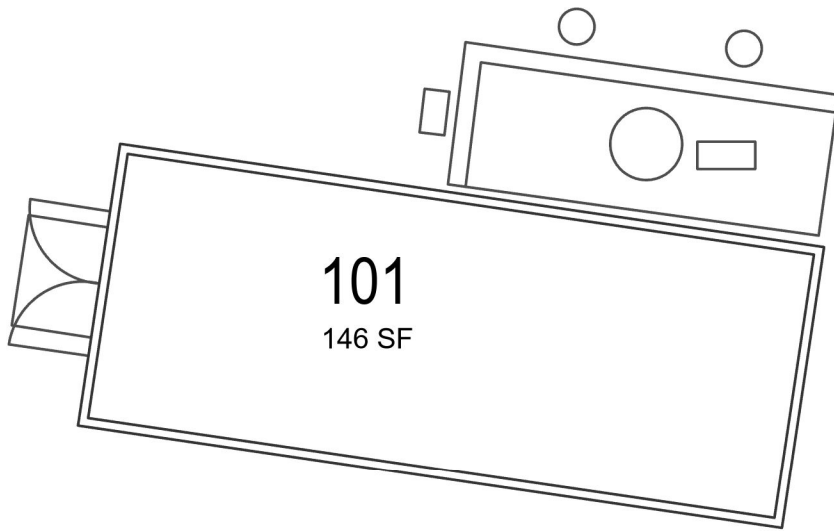

228G



CAL POLY

FACILITIES MANAGEMENT AND DEVELOPMENT

Pier Storage Container

Floor 1

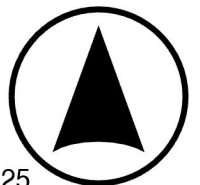

MAY 2025

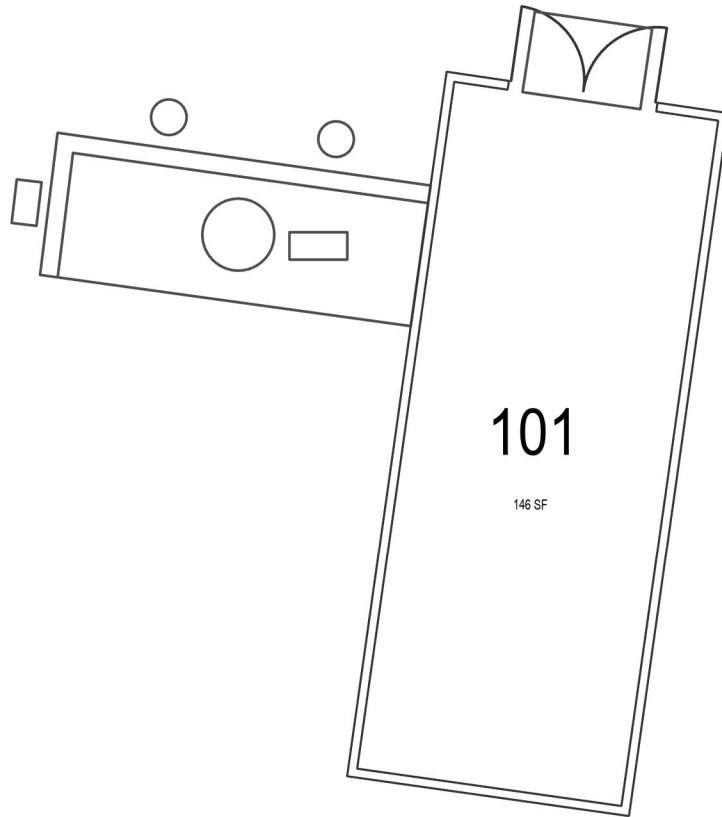

228H



CAL POLY

FACILITIES MANAGEMENT AND DEVELOPMENT

Pier Storage Container

Floor 1

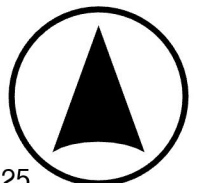

MAY 2025